



# Gunnebo SpeedStile FL<sup>s</sup>

## MAX Series

Flap Leaf Speed Gate for Internal Installation

**GUNNEBO**<sup>®</sup>

## Flap Leaf Speed Gate for Internal Installation

### Motorised flap leaves

Minimal footprint, transparent and user-friendly design for all users, for sites where limited space is required and aesthetics is important. Quiet and smooth in operation, the SpeedStile FL<sup>®</sup> MAX has a stainless steel frame and tempered glass lid and can be finished with either square tempered glass, or round stainless steel ends. Available in a selection of clear passage widths, flap leaf heights, top lid materials, finishes and options.

One-leaf service-gate solution for extra wide service passage, also available. Applications include Leisure, Government, Finance, Banking, Retail, Telecommunications, Information Technology, Publishing, Education...

## Security Features

### Fraud Detection through sophisticated and proven algorithm

Intrusion
Tailgating
Piggybacking
Wrong way direction
Leave aisle timeout
Climb-on/over detection (optional)

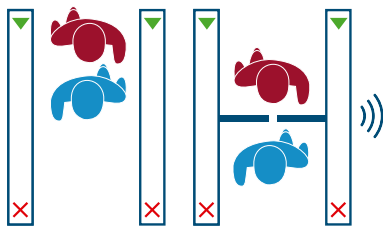

Tailgating and piggybacking detection

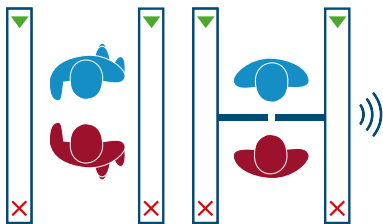

Wrong way and intrusion detection

## Mode of Operation

### Flap Leaves

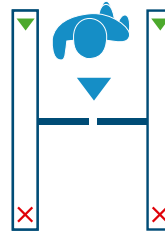

#### Normally Closed

Passage in one or both directions is electronically controlled. On receiving a signal from the access control system, or remote control, the flap leaves open (Normally Closed NC). If an unauthorised person

tries to tailgate or attempts to enter from the opposite direction, the in-built alarm system is activated. If within the pre-set timeout no passage has occurred, the lane will close and reset.

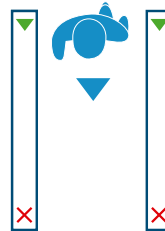

#### Normally Open

Normally Open N/O provides an open walkway in rest position and will only close at unauthorised entry or tailgating attempts.

## User Guidance

### LED display pictogram

Indicators flush mounted on the column drive post, with illuminated symbols.

Steady light = Normal use. Flashing light = Alarm conditions



Green Arrow

**Steady:** Authorised use or designated free passage Proceed through the unit.

**Flashing:** Emergency/Fire exit.

Red Cross

**Steady:** Unit in use or no passage. Passage not authorised.

**Flashing:** Alarm, fraudulent condition or technical alarm.

## Dynamic Passage Lighting and Enhanced Audio (Optional)

Additional passenger guidance given by visual and audible cues using dynamic LED strip lighting and audio driver.

### Idle State:

LED strip glows blue

### Valid Passage:

LED strip traces green in the direction of travel and an audible indication is made <sup>1</sup>

### Alarm condition:

LED strip flashes red and an audible alarm is played.

<sup>1</sup> LED strip colour and audio played is customisable depending on customer requirement

## Anti-Climb Detection (Optional)

Detection of climb-on and climb-over frauds raises visual and audible alarms.

### Climb-on (attempted fraud):

Detection of an intruder climbing on to one end of the cabinet

### Climb-over (successful fraud):

Detection of an intruder passing from one end of the cabinet to the other

## Safety Features

---

Safety force sensing

---

Lower safety sensors (option)

---

Accurate presence sensing

---

Emitter/receiver infrared sensors technology

---

Logic voltage 24 V dc

---

Voltage free contact input for Fire Alarm fail state

---

Manual push opening on power off

---

Anti-panic push opening in operation

---

Wide walkway for wheelchair or easier access

---

Accompanied wheelchair or child passage management

---

For security and safety reasons children must be supervised by an adult at all times in the vicinity of an active lane. Any child being escorted through the lane must always precede the accompanying adult during passage.

## Design / Construction

Slim and transparent design with square or rounded end legs and tempered glass lid in Stainless Steel and glass finish.

Available cabinet design construction:

**Glass leaf height:** 880mm / 1200mm / 1500mm / 1800mm available for any length.

**Length:** 1314mm (Square End) / 1532mm (Round End)

Standard passage 600mm and Wide passage (900mm) available. Available also as Combi – centre cabinet with narrow (600mm) passage in one side and wide (900mm) passage on the other side

In order to create a lane it is necessary to have one right and one left cabinet. To create more than one lane, use one or more centre or combi cabinets. Select cabinets according to the number of lanes and passage width desired.

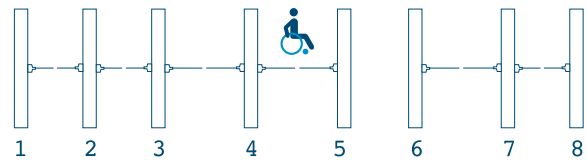

1. Left 2. Centre 3. Combi RW 4. Centre Wide  
5. Right Wide 6. Left Wide 7. Combi RW 8. Right

## Finishes

Frame and rotor column finishing in 304 grade stainless steel and glass inlay 10mm thick.

Standard finish for lid: Tempered glass with black silk screen

End legs: Square – Tempered glass with black silk screen.  
Round – 304 grade stainless steel

Optional LEDs integrated into the top channel illuminate cabinet glass and surrounding area.

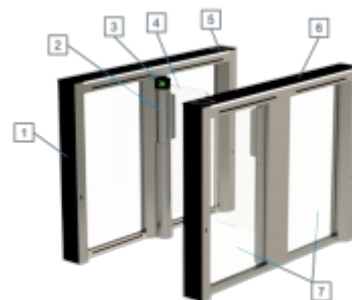

1. End Leg 2. Rotor Column 3. LED display indicators 4. Flap leaves  
5. Card Reader Integration 6. Top Lid 7. Glass

## Product Range



SpeedStile FL<sup>s</sup> MAX | Square End Legs



SpeedStile FL<sup>s</sup> MAX | Round End Legs

## Options & Accessories

Dynamic Lights and Enhanced Audio	Ambient LED lighting
Climb-Over Detection	Remote control systems
Alternative finishes and materials	Wheelchair Sensor
Lower safety sensor kit	One-Leaf Service Gate version to pair with adjacent FLs lanes
Card reader integration	

## Access Specifications

### Flow rates by type of reader<sup>1</sup>

Insertion type	Swipe type	Proximity type
20 Passages per minute	30 Passages per minute	40 Passages per minute

1. Approximate figures.

### Accessibility for Standard (600mm) vs. Wide (900mm) models

Plain dot indicates the functionality is implemented, empty dot indicates some limitations, no dot indicates not available. Emergency egress<sup>2</sup> functionality implemented as standard.

600mm	•	•	•	•	•	○	○			○
900mm	•	•	•	•	•	○	○	•	•	•

Disabled Access: 900mm net passage way and algorithm able to manage wheelchair access.  
 2. In the event of a power failure the flap leaves will remain in the current position.

## Electrical Data & Conditions of Use

Power Supply	Power Rating	Power Rating	Fire Signal	Operating Temperature	IP Rating	Noise Level
230Vac 50Hz <sup>1</sup>	20VA	120VA	Input for voltage free contact	+5°C to + 40°C RH 95%	IP20	Less than 55dB <sup>2</sup>

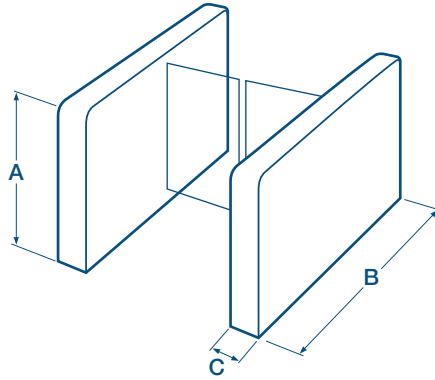

## Dimensions & Weights

	Glass leaves Overall Height	Passage Width	A Cabinet Height	B Cabinet Length	C Cabinet Width <sup>1</sup>	Weight (kg) Side Cabinet	Weight (kg) Centre Cabinet
Square Ends – Standard	880/1200/1500 /1800	600	982	1314	132	70	85
Square Ends – Wide	880/1200/1500 /1800	900	982	1314	132	70	85
Round Ends – Standard	880/1200/1500 /1800	600	982	1532	132	75	90
Round Ends – Wide	880/1200/1500 /1800	900	982	1532	132	75	90

Dimensions in (mm). Weight net (kg). Might require lifting equipment. For details refer to installation detail drawings.

1. Add 59mm for side cabinet or 118mm for centre cabinet due to column rotor

## Installation & Maintenance

Product Delivery	Application	Site Preparation <sup>1</sup>	Cabling & Conduits <sup>2</sup>	Control Board Location	Systems Integration <sup>5</sup>	Systems Integration <sup>5</sup>	Maintenance Access	MTTR <sup>3</sup>	MCBF <sup>4</sup>
Pre-assembled	Indoor	Flat & level finished floor +/- 5mm	Through the ground	Rotor Column	27 digital interface I/O RS232 RS485	Settings programmable via parameters	Drive column and lid access	Less than 30 minutes	4 Million

1. Bolting depth MIN 70mm, concrete MIN fckcube30N/mm<sup>2</sup> resistance, MIN 1300 (1500 or 2000 depending on the cabinet length) x 400 x150mm deep. 2. Running MIN 140mm below finished floor level, should rise MIN 50mm from foundation. 3. Potential free contact for card reader input 4. Mean time To Repair. 5. Mean Cycle Between Failure.

It is the customer's responsibility to ensure the structural integrity and strength of the installation location.

Data provided is for information only, please refer to your usual Gunnebo Customer Service contact in order to prepare the installation site.



**Want to see SpeedStile in full action?**  
Scan this QR code with your smartphone.  
Or search for "SpeedStile FLs" on YouTube.

# Gunnebo SpeedStile FL<sup>s</sup>

Design and production: Gunnebo. Photos Credits: Gunnebo. The data given in this material may be subject to change without further notice. The Gunnebo logos and "Gunnebo - For a safer world" are registered trademarks of Gunnebo AB. SpeedStile\_FLs\_MAX\_1.0



Take advantage of our knowledge:  
[www.gunneboentrancecontrol.com](http://www.gunneboentrancecontrol.com)

**GUNNEBO**®